

Chip Common Mode Filter—CM Series

Construction

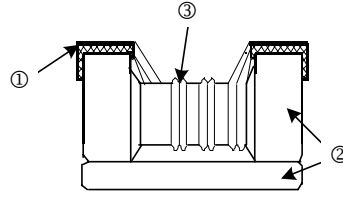

① Terminal	② Ferrite	③ Enamel-insulated Wire
------------	-----------	-------------------------

Features

- Small chip inductor with ferrite core and two line types wire wound
- Highly effective in noise suppression High common-mode impedance at noise band and low differential-mode impedance at signal band
- Low differential-mode impedance with high coupling factor. There is almost no distortion on high-speed signal.
- Operating temperature -40°C~85°C

Dimensions

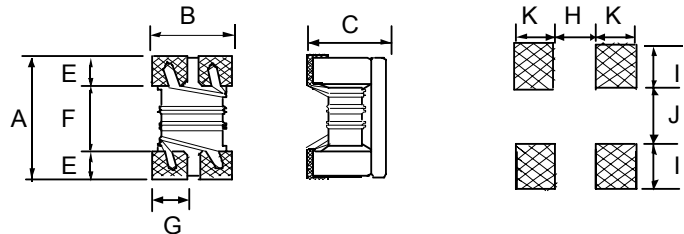

Unit: mm

Type	Size (Inch)	A	B	C	E	F	G	H	I	J	K	Weight (g) (1000pcs)
CMH05	0805	2.0±0.2	1.2±0.2	1.2±0.2	0.45	1.2	0.4	0.8	0.4	0.4	0.90	19
CMH06	1206	3.2±0.2	1.6±0.2	1.8±0.2	0.60	2.0	0.6	1.6	0.6	0.4	1.05	53.3

Applications

- EMI Radiation Noise Suppression for Any Electronic Device
- USB Line for Personal Computers and Peripheral
- IEEE 1394 Line for Personal Computers, DVC, STB
- LCD Panels. Low-Voltage Differential Signal (LVDS)

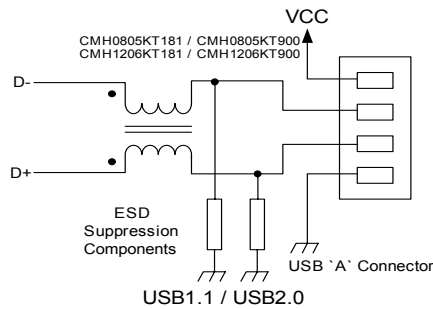
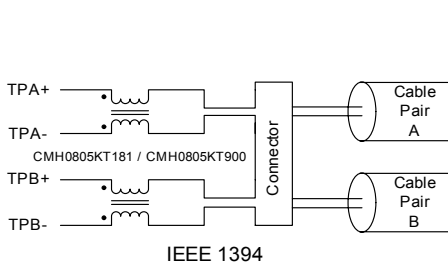

Part Numbering

CM	H	05	M	T	900
Product Type	Shielding Type H: Shielding	Dimensions 05: 0805 06: 1206	Impedance Tolerance M: ±20%	Packaging Code T: Taping Reel B: Bulk	Impedance 900: 90Ω 121: 120Ω 102: 1000Ω 222: 2200Ω

■ Standard Electrical Specifications

CMH05 / Standard Type

Impedance (Ω)	Tolerance	Test Condition (MHz)	DCR (Ω) max.	IDC (mA) max.	Rated Voltage Vdc (V)	Withstanding Voltage Vdc (V)	Insulation Resistance (MΩ) min.
67	±20%	100	0.25	400	50	125	10
90	±20%	100	0.35	330	50	125	10
120	±20%	100	0.30	370	50	125	10
180	±20%	100	0.35	330	50	125	10
200	±20%	100	0.35	330	50	125	10
260	±20%	100	0.40	300	50	125	10
360	±20%	100	0.40	280	50	125	10
370	±20%	100	0.40	280	50	125	10

CMH06 / Standard Type

Impedance (Ω)	Tolerance	Test Condition (MHz)	DCR (Ω) max.	IDC (mA) max.	Rated Voltage Vdc (V)	Withstanding Voltage Vdc (V)	Insulation Resistance (MΩ) min.
90	±20%	100	0.30	370	50	125	10
160	±20%	100	0.40	340	50	125	10
260	±20%	100	0.50	310	50	125	10
600	±20%	100	0.80	260	50	125	10
1000	±20%	100	1.00	230	50	125	10
2200	±20%	100	1.20	200	50	125	10

■ All specifications are subject to change without notice

Characteristics (Impedance vs. Frequency)-CMH05

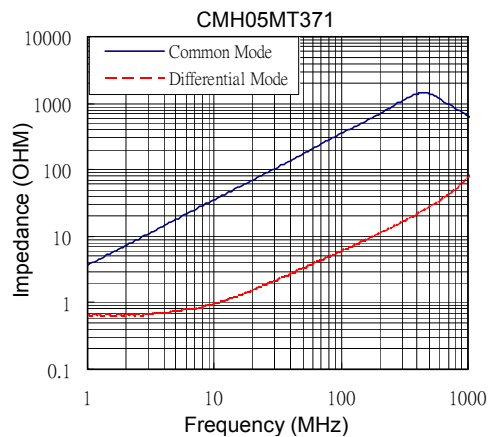
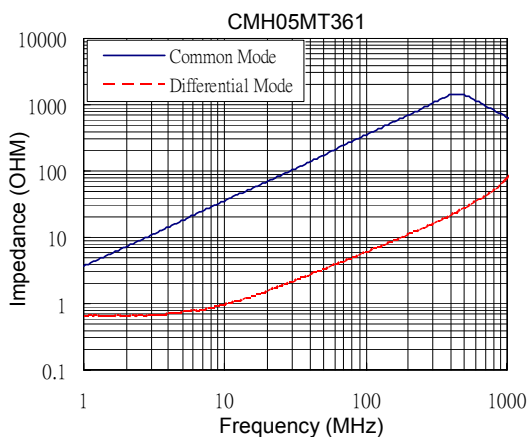
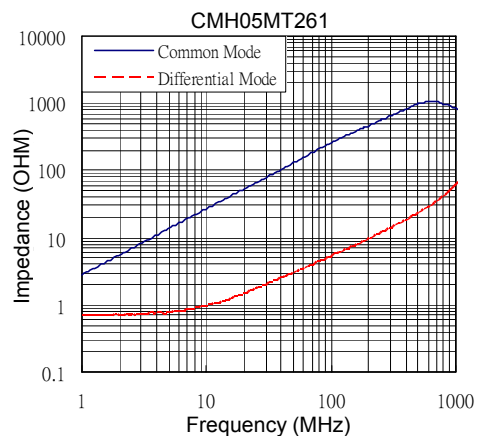
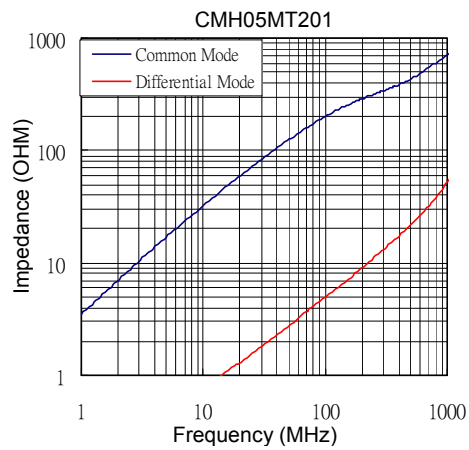
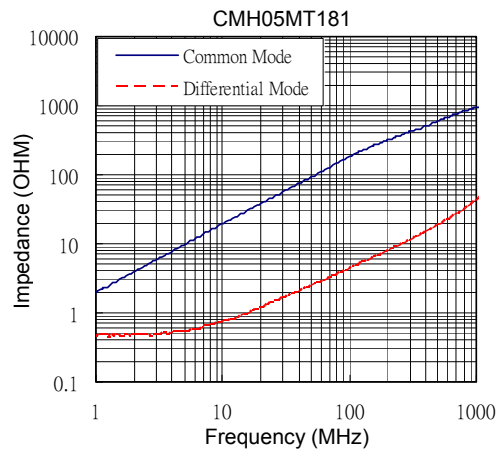
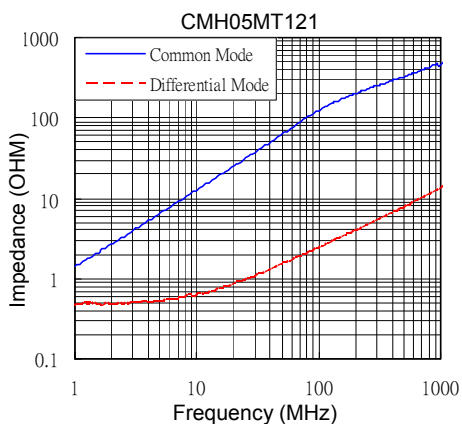
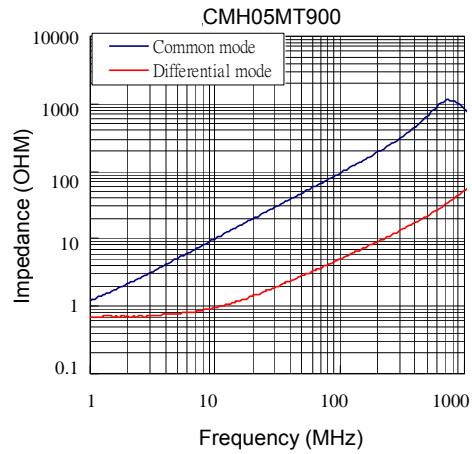
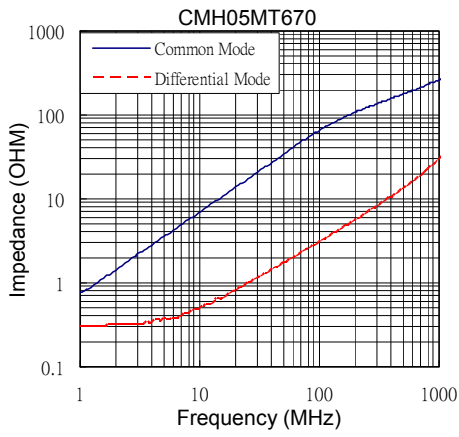

■ Characteristics (Impedance vs. Frequency)-CMH06

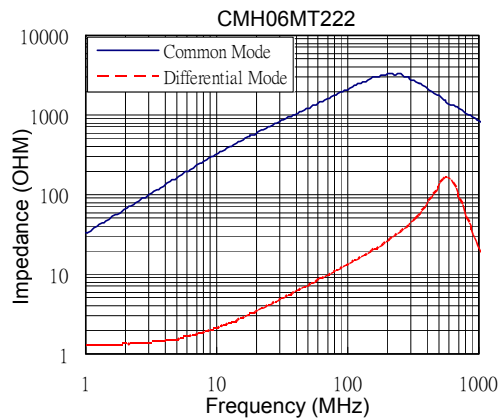
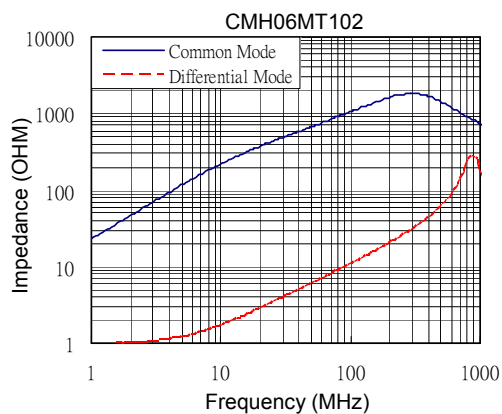
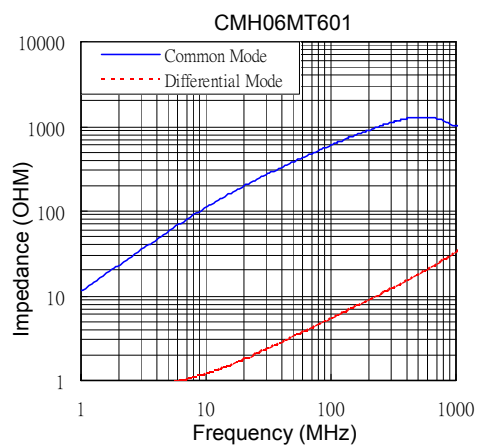
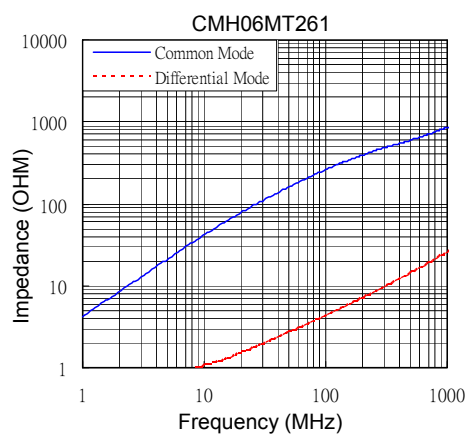
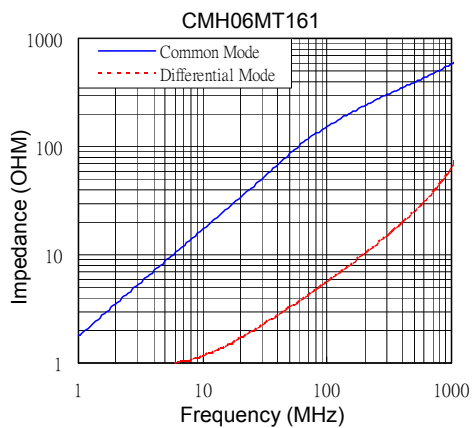
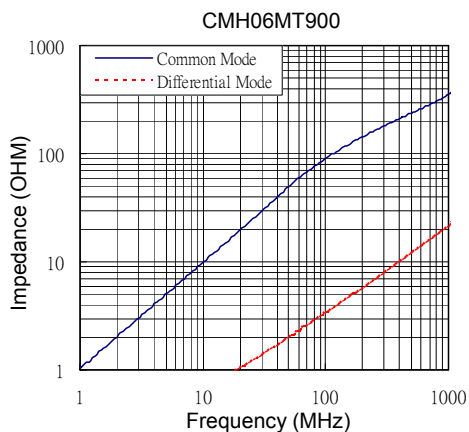

■ Environmental Characteristics

Electrical Performance Test

Items	Requirement	Test Conditions / Test Methods
Impedance	Refer to standard electrical characteristic spec. Component should not be damaged	LCR Meter HP 4291B
DC Resistance DCR		Micro-Ohm meter (GOM-801G)
Withstand Voltage (VDC)		Test Voltage: 2.5 Times Rated Voltage Testing Time: 60 seconds Charge Current: 0.5mA
Rated Voltage (VDC)		Test Voltage: Rated Voltage Testing Time: 1 to 5 seconds Charge Current: 1mA
Insulation Resistance (I.R)		Charge Current: 1minute 10M ohm min.

Mechanical Performance Test

Items	Requirement	Test Conditions / Test Methods
Component Adhesion (Push Test)	Base: 0805 \geq 2 Lbs Cover: 0805 \geq 1 Lbs Base: 1206 \geq 4 Lbs Cover: 1206 \geq 2 Lbs	The component should be soldered ($232^{\circ}\text{C} \pm 5^{\circ}\text{C}$ for 10 sec.) to tinned copper substrate Applied force gauge to the side of component It must withstand force of 2 or 4 pounds without failure of the component.
Drop	Component should not be damaged	Dropping chip by each side and corner. Drop 10 times in total Drop height: 100 cm Drop weight: 125 g
Solderability	The terminal should at least be 90% covered with solder	The component shall be dipped in a melted solder bath at $245 \pm 5^{\circ}\text{C}$ for 3 seconds
Vibration Test (Low Frequency)	Component should not be damaged	1. Amplitude: 1.5 m/m 2. Frequency: 10-55-10Hz (1min.) 3. Direction: X, Y, Z 4. Duration: 2 Hrs/X, Y, Z

Climatic Test

Items	Requirement	Test Conditions / Test Methods
Low Temperature Storage	Impedance change: Within $\pm 20\%$ Without distinct damage in appearance	1. Temp: $-40 \pm 2^{\circ}\text{C}$ 2. Time: 1000 ± 48 Hours 3. Component should be tested after 1hour at room temperature
Thermal Shock		<p>Total: 5 Cycles</p>
High Temperature Storage		1. Temp: $85 \pm 2^{\circ}\text{C}$ 2. Time: 1000 ± 48 Hours 3. Component should be tested after 1hour at room temperature
Humidity		1. Temp: $40 \pm 2^{\circ}\text{C}$ 2. R.H. : 90 ~ 95% 3. Time: 48 ± 2 Hours
High Temperature Load Life		1. Temp: $85 \pm 2^{\circ}\text{C}$ 2. Time: 96 ± 12 Hours 3. Load: Allowed DC Current
Low Temperature Load Life	1. Temp: $-40 \pm 2^{\circ}\text{C}$ 2. Time: 96 ± 12 Hours 3. Load: Allowed DC Current	

■ Storage Temperature: $25 \pm 3^{\circ}\text{C}$; Humidity < 80%RH

■ Packaging

Packaging Quantity

Type	Embossed Plastic Tape (EA)
CMH05	2,000
CMH06	2,000

Reel Specifications

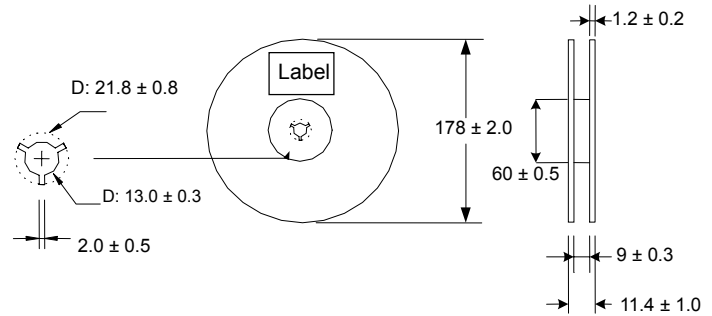

Embossed Plastic Tape Specifications

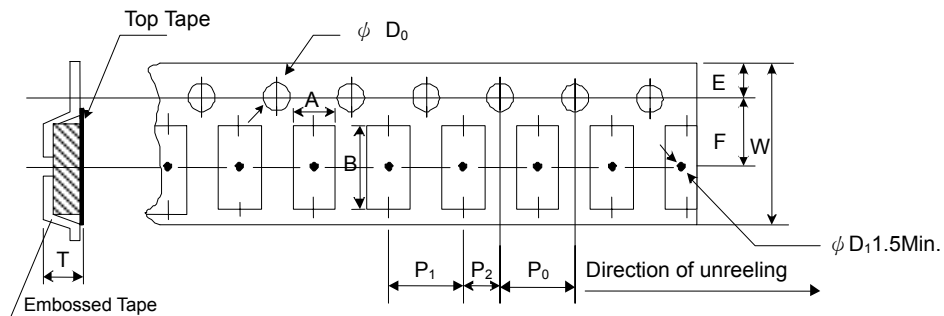

Unit: mm

Type	A	B	W	E	F	P ₀	P ₁	P ₂	ϕD ₀	T
CMH05	1.40±0.10	2.55±0.05	8.0±0.20	1.75±0.10	3.5±0.10	4.00±0.10	4.00±0.10	2.00±0.10	1.50±0.10	1.35±0.10
CMH06	1.90±0.10	3.50±0.05	8.0±0.20	1.75±0.10	3.5±0.10	4.00±0.10	4.00±0.10	2.00±0.10	1.50±0.10	2.10±0.10

Leader / Tape

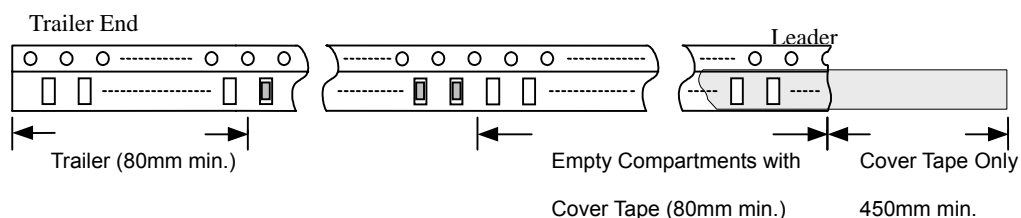

Peel-off Force

The force for tearing off cover tape is 0.05~0.69 (N) in the arrow direction at the following conditions:

Temperature: 5 ~ 35°C

Humidity: 45 ~ 85%

Atmospheric pressure: 860 ~ 1060hpa

